



# TITAN

GENERATORI D'ARIA CALDA A GRANDE PORTATA A COMBUSTIONE INDIRECTA  
CON VENTILATORE CENTRIFUGO

INDIRECT COMBUSTION HEAVY DUTY MOBILE SPACE HEATERS WITH CENTRIFUGAL FAN



## TITAN - GENERATORI D'ARIA CALDA A GRANDE PORTATA A COMBUSTIONE INDIRECTA CON VENTILATORE CENTRIFUGO

- Cassetto di copertura del bruciatore che consente la protezione da urti, polvere, acqua, eventi atmosferici e vasca di raccolta del gasolio/condensa
- Bruciatore dotato di presa snorkel per garantire aria di combustione pulita mediante collegamento con guaina di aspirazione dall'esterno
- Il nuovo scambiatore di calore abbinato ai nuovi ventilatori di maggiori prestazioni permettono di ottenere un rendimento termico del 96%;
- Un migliore ancoraggio della struttura portante della macchina grazie a robuste staffe di fissaggio che ne consentono la movimentazione su qualunque superficie
- Struttura portante con pannelli rimovibili per il lavaggio interno, anche a macchina appesa
- Pannelli con pieghe di rinforzo a croce per garantire maggior rigidità e robustezza
- Utilizzo esclusivamente di viti e inserti metrici per il fissaggio, no viti autofilettanti
- Protezione scarico fumi camera di combustione in materiale plastico con catene di ritenzione
- Ventilatore protezione (IP 55):
  - molto silenzioso (rumore  $\leq 69$  db a 2 metri);
  - ad alta prevalenza e prestazioni che garantisce un'elevata portata d'aria e pressione statica (500 Pa) per la diffusione omogenea ed a lunga distanza dell'aria calda mediante canalizzazioni o guaine;
  - ventilatore ancorato alla struttura portante mediante robusti longheroni e staffe di fissaggio;
  - serranda regolabile di ripristino aria fresca;
- Quadro elettrico posteriore di comando (IP 65):
  - posizionato nella parte posteriore evita che sia a contatto con polvere, acqua, neve etc;
  - provvisto di una robusta copertura metallica che consente anche il ricovero di attrezzi e documenti;
- Quadro elettrico anteriore di servizio (IP 65):
  - posizionato nella parte anteriore della macchina dentro il cassetto copertura bruciatore: per evitare che sia a contatto con polvere, acqua, neve per una più facile manutenzione; per un più agevole controllo ed intervento dell'operatore
- Ciascun componente principale (ventilatore, bruciatore, termostati, etc.) è munito di connessioni rapide di collegamento elettrico:
  - velocità di montaggio/smontaggio e di intervento tecnico;
  - eliminazione di errori di installazione/smontaggio.

- *Burner cover: protects the burner against blows, dust, water, weather and collect diesel fuel/condensation recovery basin*
- *Burner is supplied with snorkel jack to ensure clean air combustion through connection with outdoor air uptake duct*
- *The new heat exchanger with the newly designed higher performance fans ensure heat efficiency of 96%*
- *Better anchorage to the machine's weight bearing structure through sturdy attachment rods which allow for movement on any floors*
- *Bearing structure with removable panels for interior washing, also in hanging models*
- *Panels with reinforcement cross pleats to ensure superior rigidity and strength*
- *Exclusive use of metric screws and inserts for fastening, no self-tapping screws*
- *Protection cap of combustion chamber exhaust in plastic material with retention chains guards*
- *Ventilator (IP 55):*
  - *very low noise fan (noise level  $\leq 69$ db at 2 meters)*
  - *high output, high performance fan guarantees increased air flow and static pressure (500 Pa) for uniform and long distance diffusion of warm air through channels or ducts*
  - *fan anchorage on machine's bearing structure through sturdy rods*
  - *adjustable fresh air re-uptake shutter*
- *Control rear electrical panel (IP 65):*
  - *located at the top rear of the machine to avoid contact with dust, water, snow*
  - *supplied with a sturdy metal cover to prevent damage and unauthorized access; also handy for storage of tools, papers, etc;*
- *Service front electrical panel (IP 65):*
  - *located at the front of the machine inside the burner cover lid: to prevent contact with dust, water, snow; for easier maintenance; to facilitate controls and maintenance by the operator*
- *Every main component (fan, burner, thermostats, etc.) is supplied with quick couplings of electrical connections:*
  - *fast assembly, disassembly and technical maintenance*
  - *eliminates installation/disassembly mistakes*

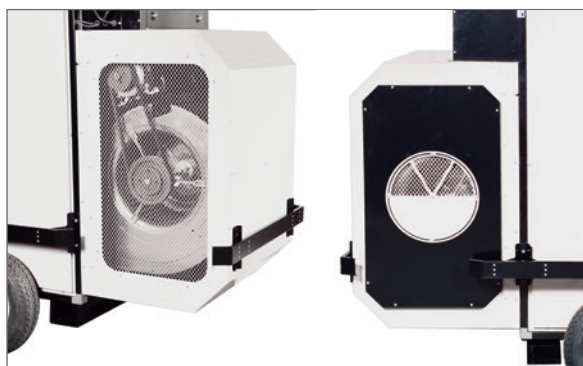
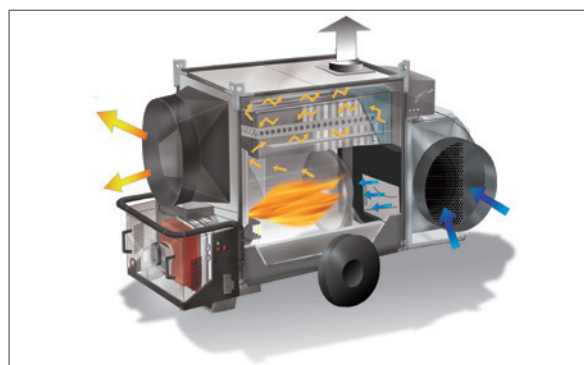

TITAN - INDIRECT COMBUSTION HEAVY DUTY MOBILE SPACE HEATERS WITH CENTRIFUGAL FAN

ACCESSORI A RICHIESTA / ACCESSORIES ON DEMAND

RACCORDO 1 VIA ONE WAY ADAPTER	RACCORDO 2 VIE TWO WAYS ADAPTER
 	 
<p>Mod. TITAN 145 (Ø 600 mm) Cod. 02AC871</p>	<p>Mod. TITAN 145 (Ø 500 mm) Cod. 02AC872</p>
<p>Mod. TITAN 185 (Ø 650 mm) Cod. 02AC881</p>	<p>Mod. TITAN 185 (Ø 500 mm) Cod. 02AC882</p>
<p>Mod. TITAN 235 (Ø 700 mm) Cod. 02AC891</p>	<p>Mod. TITAN 235 (Ø 600 mm) Cod. 02AC892</p>
RACCORDO 4 VIE FOUR WAYS ADAPTER	GUAINE FLESSIBILI IN PVC L= 6 m CON CINGHIA DI FISSAGGIO FLEXIBLE AIR DUCTS 6 m WITH CLIP
 	  
<p>Mod. TITAN 145 (Ø 350 mm) Cod. 02AC873</p>	<p>Mod. Ø 350 mm Cod. 02AC563</p>
<p>Mod. TITAN 185 (Ø 350 mm) Cod. 02AC883</p>	<p>Mod. Ø 400 mm Cod. 02AC564</p>
<p>Mod. TITAN 235 (Ø 400 mm) Cod. 02AC893</p>	<p>Mod. Ø 450/500 mm Cod. 02AC566</p>
<p>Mod. TITAN 235 (Ø 400 mm) Cod. 02AC893</p>	<p>Mod. Ø 600 mm Cod. 02AC567</p>
	<p>Mod. Ø 650/700 mm Cod. 02AC568</p>

# TITAN - GENERATORI D'ARIA CALDA A GRANDE PORTATA A COMBUSTIONE INDIRECTA CON VENTILATORE CENTRIFUGO

RACCORDO ASPIRAZIONE 1 VIA AIR INLET ADAPTER	GUAINA RINFORZATA PER RIPRESA ARIA REINFORCED FLEXIBLE AIR INLET DUCT
	
<p><b>Mod.</b> TITAN 145 (Ø 645 mm) <b>Cod.</b> 02AC874</p>	<p><b>Mod.</b> TITAN 145 (Ø 650 mm, l=6m) <b>Cod.</b> 02AC797</p>
<p><b>Mod.</b> TITAN 185 (Ø 715 mm) <b>Cod.</b> 02AC884</p>	<p><b>Mod.</b> TITAN 185 (Ø 720 mm, l=6m) <b>Cod.</b> 02AC798</p>
<p><b>Mod.</b> TITAN 235 (Ø 745 mm) <b>Cod.</b> 02AC894</p>	<p><b>Mod.</b> TITAN 235 (Ø 750 mm, l=6m) <b>Cod.</b> 02AC804</p>
	<p><b>Mod.</b> Tutti/All Fascetta fissaggio guaina- clip for flexible duct (Ø 400-750 mm) <b>Cod.</b> 02AC663</p>
KIT SERBATOIO TANK KIT	KIT PARAURTI LATERALE SIDE BUMPERS KIT
 <p>INDICATORE DI LIVELLO/FUEL LEVEL GAUGE</p>	
<p><b>Mod.</b> TITAN 145 (litri/liters= 120) <b>Cod.</b> 02AC847</p>	<p><b>Mod.</b> TITAN 145 <b>Cod.</b> 02AC875</p>
<p><b>Mod.</b> TITAN 185 (litri/liters= 170) <b>Cod.</b> 02AC857</p>	<p><b>Mod.</b> TITAN 185 <b>Cod.</b> 02AC885</p>
<p><b>Mod.</b> TITAN 235 (litri/liters= 200) <b>Cod.</b> 02AC867</p>	
<p><b>Mod.</b> Indicatore di livello - Fuel level gauge <b>Cod.</b> 02AC510</p>	<p><b>Mod.</b> TITAN 235 <b>Cod.</b> 02AC895</p>

## TITAN - INDIRECT COMBUSTION HEAVY DUTY MOBILE SPACE HEATERS WITH CENTRIFUGAL FAN













KIT STAFFE INFORCOLAMENTO LIFTING KIT	KIT RUOTE PIVOTTANTI SWIVELLING WHEELS KIT	BRUCIATORE GASOLIO ECOFLAM ECOFLAM DIESEL BURNER
		
Mod. TITAN 145 Cod. 02AC846	Mod. TITAN 145 / 185 (Ø 150 mm) Cod. 02AC816*	Mod. TITAN 145 DIESEL/OIL Cod. 072B103
Mod. TITAN 185 Cod. 02AC856		Mod. TITAN 185 DIESEL/OIL Cod. 072B104
Mod. TITAN 235 Cod. 02AC866		Mod. TITAN 235 DIESEL/OIL Cod. 072B105
BRUCIATORE GASOLIO RIELLO RIELLO DIESEL BURNER	BRUCIATORE RIELLO GPL + RAMPA GAS LPG RIELLO BURNER + GAS TRAIN	BRUCIATORE RIELLO METANO + RAMPA GAS NATURAL GAS RIELLO BURNER + GAS TRAIN
		
Mod. TITAN 145 DIESEL/OIL Cod. 076B103	Mod. TITAN 145 GPL/LPG Cod. 074B103-05	Mod. TITAN 145 METANO/NATURAL GAS Cod. 074B104-05
Mod. TITAN 185 DIESEL/OIL Cod. 076B104	Mod. TITAN 185 GPL/LPG Cod. 074B103-07	Mod. TITAN 185 METANO/NATURAL GAS Cod. 074B104-07
Mod. TITAN 235 DIESEL/OIL Cod. 076B105	Mod. TITAN 235 GPL/LPG Cod. 074B105-08	Mod. TITAN 235 METANO/NATURAL GAS Cod. 074B106-08
PASSAPARETE SNORKEL + GUAINA FLESSIBILE SNORKEL PASS PLATE + FLEXIBLE DUCT	KIT SERRANDA TAGLIAFUOCO MANDATA ARIA (REI 120) AIR OUTLET FIRE SHUTTER KIT (REI 120)	KIT SERRANDA TAGLIAFUOCO INGRESSO ARIA (REI 120) AIR INLET FIRE SHUTTER KIT (REI 120)
		
Mod. TITAN 145/185 (Ø 100 mm) Cod. 02AC793	Mod. TITAN 145 Cod. 02AC878	Mod. TITAN 145 (Ø 645 mm) Cod. 02AC910**
Mod. Guaina /Duct TITAN 145/185 RIELLO (Ø 100 mm, l=5m) Cod. 02AC577	Mod. TITAN 185 Cod. 02AC888	Mod. TITAN 185 (Ø 715 mm) Cod. 02AC911**
Mod. TITAN 235 (Ø 150 mm) Cod. 02AC794	Mod. TITAN 235 Cod. 02AC898	Mod. TITAN 235 (Ø 745 mm) Cod. 02AC913**
Mod. Guaina /Duct TITAN 235 RIELLO (Ø 150 mm, l=5m) Cod. 02AC792		

\* Montabili solo in assenza di serbatoio installato - Only without tank



\*\* Necessario abbinamento a "raccordo aspirazione" - Additionally it's necessary to buy "air inlet adapter"



# TITAN - GENERATORI D'ARIA CALDA A GRANDE PORTATA A COMBUSTIONE INDIRECTA CON VENTILATORE CENTRIFUGO

<p>TERMOSTATO AMBIENTE +5/+30°C CON CAVO L=10 m E SPINA 90° ROOM THERMOSTAT +5/+30°C CABLE 10 m, PLUG 90°</p>	<p>TERMOSTATO AGRICOLTURA/CANTIERE -5/+50°C CON CAVO L=10 m E SPINA 90° HEAVY DUTY THERM. -5/+50°C CABLE 10 m, PLUG 90°</p>	<p>TERMOSTATO ELETTRONICO DI PRECISIONE IP55 CON DISPLAY -10/+70°C SENZA CAVO E SPINA ELECTRONIC THERMOSTAT IP55 WITH DISPLAY -10/+70°C WITHOUT POWER CORD AND PLUG</p>
		
<p>Cod. 02AC581</p>	<p>Cod. 02AC582</p>	<p>Cod. 02AC294</p>
<p>FILTRO GASOLIO RISCALDANTE PRE-HEATED FUEL FILTER</p>	<p>KIT COLLEGAMENTO MONOTUBO CON FILTRO DE AERATORE SINGLE PIPE EXTERNAL FUEL TANK CONNECTION KIT WITH DE AERATOR</p>	<p>FILTRO SEPARATORE ACQUA ANTI-WATER FILTER</p>
		
<p>Cod. 02AC818</p>	<p>Cod. 02AC819</p>	<p>Cod. 02AC801</p>
<p>KIT COLLEGAMENTO BITUBO SERBATOIO ESTERNO GASOLIO (l= 5 m) + KIT ATTACCHI RAPIDI TWO-PIPE EXTERNAL FUEL TANK CONNECTION KIT (l=5 m) + QUICK CONNECTIONS KIT</p>	<p>FILTRO GAS GAS FILTER (P.in MAX 2 bar)</p>	<p>FILTRO REGOLATORE GAS GAS FILTER REGULATOR (P.in MAX 2 bar)</p>
		
<p>Mod. Kit collegamento bitubo serbatoio esterno/ Two-pipe external tank connection kit Cod. 02AC668</p>	<p>Mod. TITAN 85/110/145 (DN 25 - 1") Cod. 03AC603</p>	<p>Mod. TITAN 85/110/145 GAS METANO - NATURAL GAS (DN 25 3/4" or 1") (Pout set. 20mbar) Cod. 03AC617</p>
<p>Mod. Kit attacchi rapidi (M+F x 2)/ Quick connections kit (M+F x 2) Cod. 02AC669</p>	<p>Mod. JUMBO 185/235 (DN 32 - 1 1/4") Cod. 03AC604</p>	<p>Mod. TITAN 85/110/145 GPL - LPG (DN 25 3/4" or 1") (Pout set. 30mbar) Cod. 03AC618</p>
<p>TUBO GAS MEDIA PRESSIONE (l= 3 m) + VALVO- LA CHIUSURA + RACCORDI COLLEGAMENTO MEDIUM PRESSURE GAS HOSE (l= 3 m) + GAS VALVE + CONNECTIONS (P. MAX 10 bar)</p>	<p>TUBO GAS BASSA PRESSIONE (l= 2 m) + VALVOLA CHIUSURA + RACCORDI COLLEGAMENTO LOW PRESSURE GAS HOSE (l= 2 m) + GAS VALVE + CONNECTIONS (P.in MAX 0,5 bar)</p>	<p>TUBO SCARICO FUMI INOX L = 1 m STAINLESS STEEL EXHAUST PIPE L = 1 m</p>
		
<p>Mod. TITAN 85/110/145 Tubo/Hose gas 1" Cod. 03AC615</p>	<p>Mod. TITAN 85/110/145 Tubo/Hose gas 1" Cod. 03AC612</p>	<p>Mod. TITAN 85/110 (Ø 150 mm) Cod. 02AC285</p>
<p>Mod. TITAN 185/235 Tubo/Hose gas 1 1/4" Cod. 03AC616</p>		<p>Mod. TITAN 145/185/235 (Ø 200 mm) Cod. 02AC287</p>

## TITAN - INDIRECT COMBUSTION HEAVY DUTY MOBILE SPACE HEATERS WITH CENTRIFUGAL FAN

TERMINALE PER CAMINO IN INOX STAINLESS STEEL CHIMNEY POT	KIT SUPPORTO SCARICO FUMI CHIMNEY SUPPORT KIT	KIT RICOVERO SCARICO FUMI CHIMNEY HOLDER KIT
		
<b>Mod. TITAN 145/185/235 (Ø 200 mm)</b> <b>Cod. 02AC658</b>	<b>Mod. TITAN 145/185/235</b> <b>Cod. 02AC814</b>	<b>Mod. TITAN 145</b> <b>Cod. 02AC844</b> <hr/> <b>Mod. TITAN 185</b> <b>Cod. 02AC854</b> <hr/> <b>Mod. TITAN 235</b> <b>Cod. 02AC864</b>

### Quadro elettrico posteriore- Rear electrical panel

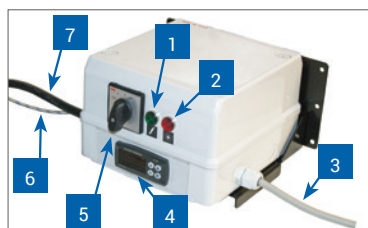

#### Legenda

- 1 Alimentazione elettrica
- 2 Surriscaldamento motore (solo per trifase)
- 3 Cavo motore
- 4 Termoregolatore che consente:
  - il settaggio del termostato FAN per il controllo ventilatore: pre riscaldamento e post ventilazione camera di combustione
  - il settaggio termostati LIMIT per il controllo del bruciatore
  - la visualizzazione delle ore di funzionamento macchina
  - la temperatura uscita aria dalla mandata
  - modifiche settaggio tramite password
- 5 Interruttore 4 posizioni:
  - O**= STOP
  - V**= VENTILAZIONE (ARIA FRESCA)
  - H**= RISCALDAMENTO
  - H+V**= RISCALDAMENTO CON VENTILAZIONE CONTINUA
- 6 Sonda termoregolatore
- 7 Cavo alimentazione

#### Legend

- 1 Electrical power supply
- 2 Motor overheat (only for three-phase)
- 3 Motor cable
- 4 Thermoregulator allows for:
  - FAN thermostat setting to control the fan: before heating and after ventilation of combustion chamber
  - LIMIT thermostat setting for burner control
  - display of machine's hours of work
  - temperature of air exiting the outlet
  - setting changes with password
- 5 Switch 4 positions:
  - O**= STOP
  - V**= VENTILATION (FRESH AIR)
  - H**= HEATING
  - H+V**= HEATING WITH CONTINUOUS VENTILATION
- 6 Heat adjustment probe
- 7 Power cable

### Quadro elettrico anteriore di controllo- Service front electrical panel

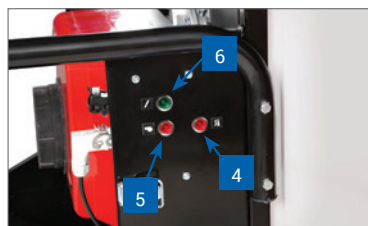
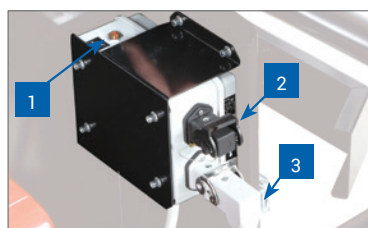

#### Legenda

- 1 OVERHEATING: termostato di sicurezza in caso di surriscaldamento con riarmo manuale
- 2 Presa filtro preriscaldamento
- 3 Presa termostato ambiente/umidistato/timer
- 4 Spia surriscaldamento termostati (overheating limit)
- 5 Spia bruciatore
- 6 Spia alimentazione elettrica

#### Legend

- 1 OVERHEATING: safety thermostat in case of overheating, with manual reset
- 2 Pre-heating filter socket
- 3 Socket for thermostat ambient/humidistat/timer
- 4 Thermostat overheat indicator light (overheating)
- 5 Burner indicator light
- 6 Electric power indicator light

# TITAN - GENERATORI D'ARIA CALDA A GRANDE PORTATA A COMBUSTIONE INDIRETTA CON VENTILATORE CENTRIFUGO

## INDIRECT COMBUSTION HEAVY DUTY MOBILE SPACE HEATERS WITH CENTRIFUGAL FAN

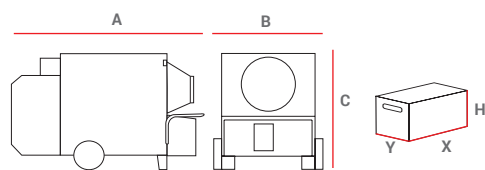

MOD	PESI E DIMENSIONI MACCHINA* WEIGHTS AND DIMENSIONS MACHINE*			IMBALLO PACKAGING				
	A [mm]	B [mm]	C [mm]	Netto/Net [kg]	X [mm]	Y [mm]	H [mm]	Lordo/Gross [kg]
TITAN 145	2191	900	1515	361	-	-	-	-
1/2	-	-	-	-	1910	780	1490	375
2/2	-	-	-	-	730	400	500	15
TITAN 185	2413	920	1620	430	-	-	-	-
1/2	-	-	-	-	2140	800	1595	435
2/2	-	-	-	-	760	400	500	15
TITAN 235	2630	1042	1840	535	-	-	-	-
1/2	-	-	-	-	2328	861	1764	524
2/2	-	-	-	-	820	450	560	22

\* Macchina completa con bruciatore e uscita 1 via  
Complete machine with burner and one way adapter

MODELLO MODEL	CODICE CODE	MONOFASE / SINGLE PHASE	TRIFASE / THREE PHASE	
		TITAN 145M * (OIL-GAS)	TITAN 185T * (OIL-GAS)	TITAN 235T * (OIL-GAS)
POTENZA TERM. NOMINALE RATED HEAT POWER	Hs [kW] Hs [kcal/h - BTU/h]	144,72 124.455 497.821	185,54 159.563 638.254	235,72 202.715 810.861
POTENZA TERMICA RESA OUTPUT HEAT POWER	Hs [kW] Hs [kcal/h - BTU/h]	138,93 119.477 477.908	178,12 153.181 612.724	227,47 195.620 782.480
RENDIMENTO EFFICIENCY	[ % ]	96,00	96,00	96,50
PORTATA D'ARIA AIR FLOW	[ m³/h ]	14.000	16.000	20.000
PRESS. STATICA DISP. AVAILABLE STATIC PRESS	[ Pa - mm H <sub>2</sub> O ]	300 - 30	500 - 50	500 - 50
SALTO TERMICO TEMPERATURE RISE	a 20°C [ °C ]	42	46	47
CAMPO DI LAVORO EFFETTIVO EFFECTIVE HEAT RANGE	[ m ]	56	63	70
CONSUMO GASOLIO OIL CONSUMPTION	[ kg/h ]	11,45	14,68	18,65
CONSUMO METANO NATURAL GAS CONSUMPTION G20	[ m³/h ]	13,855	17,682	22,035
PRESSIONE ALIM. INLET PRESSURE G20	[ mbar ]	20	20	20
CONSUMO GPL LPG CONSUMPTION G31	[ m³/h - kg/h ]	5,403 - 10,57	6,981 - 13,63	8,637 - 16,92
PRESSIONE ALIM. INLET PRESSURE G31	[ mbar ]	37	37	37
ALIMENTAZIONE ELETTRICA ELECTRICAL POWER	[ V - ph - Hz ]	230 - 1 - 50	400-3-50 (230-3-50)◆	400-3-50 (230-3-50)◆
POTENZA ELETTRICA POWER CONSUMPTION	[ W ]	3100	4200	4850 (230V) 4970 (400V)
Ø CAMINO Ø FLUE	[ mm ]	200	200	200
Ø GUAINA USCITA ARIA / L. MAX. Ø OUTLET HOSE / L. MAX	[ mm/m ] 1 VIA - 1 WAY	600 - 50	700 - 50	700 - 50
	[ mm/m ] 2 VIE - 2 WAYS	500 - 30	500 - 30	600 - 30
	[ mm/m ] 4 VIE - 4 WAYS	350 - 25	350 - 25	400 - 25
Ø GUAINA SNORKEL / L. MAX. Ø OUTLET SNORKEL / L. MAX	[ mm/m ]	100 - 6	100 - 6	150 - 6
Ø GUAINA RIPRESA ARIA / L. MAX. Ø INLET HOSE / L. MAX	[ mm/m ]	650 - 10	720 - 10	750 - 10

\* Macchina senza bruciatore ed uscita aria - Machine without burner and air adapter

◆ Disponibile su richiesta - Available on demand